

# Owner Instructions



Warning! Read instructions before using the machine

GVE 370

CT 370

CT 380

CT 470



**Numatic**  
INTERNATIONAL

[www.numatic.com](http://www.numatic.com)





Kit A26A

GVE 370-2



Kit A40A

Kit A43

CT 370-2  
CT 380-2  
CT 470-2



Wet - Assembling the machine for extraction use



Wet / extraction - Using the machine

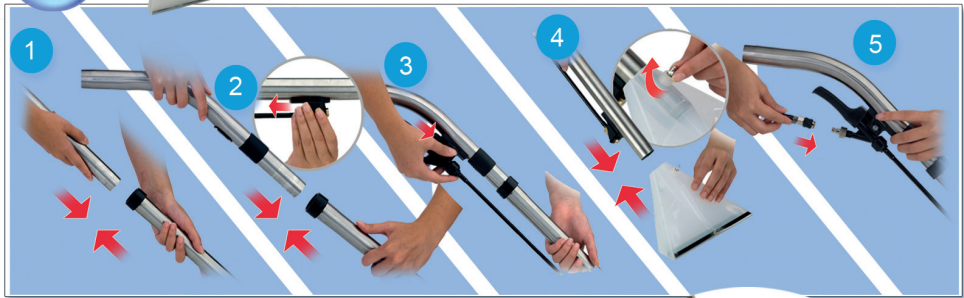

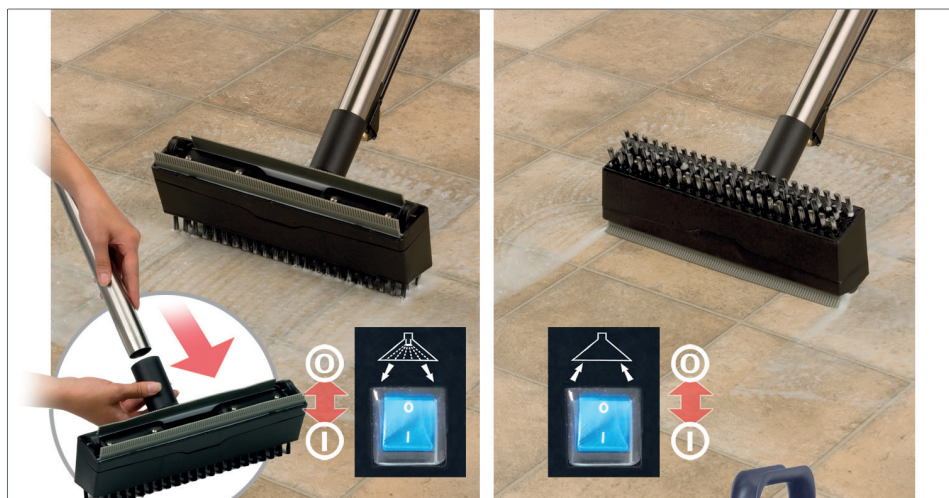

Wet / extraction - Using the machine





Dry-Assembling the machine

Dry - Using the Machine

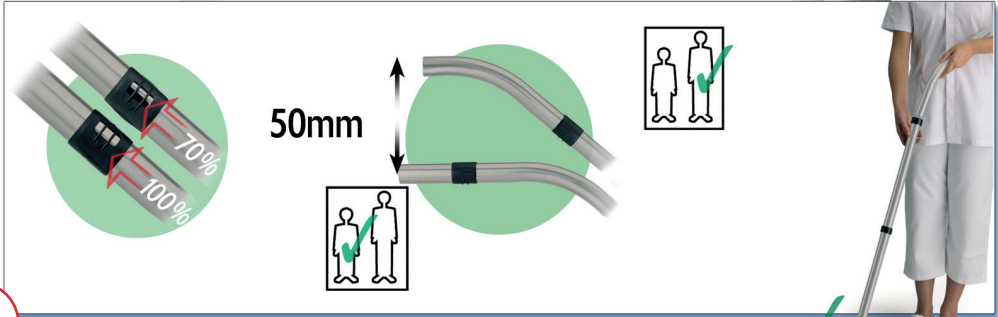



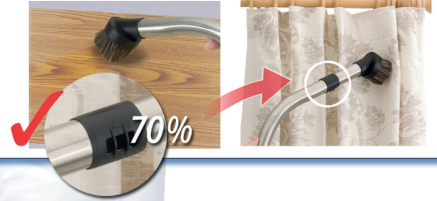

Dry - Using the machine



Re-order  
Hepaflo Bag  
Packs of 10

370/ 380 Drum 604016	470 Drum 604018
-------------------------	--------------------

470 Handle Locking Instructions

## Fitting the Face on





## Removing the Face



## About the machine

Company name and address

	<b>Numatic International Ltd</b> CHARD, ENGLAND, TA20 2GB		
	<b>GVE 370-2</b>		Machine Description
Voltage / Frequency	230V ~	200 KPa (2 Bar)	Max Pressure
Power Rating	50 - 60Hz 1200W MAX 1000W IEC	IPX4	Splash-proof Rating
Yr / Wk / Serial Number	 101229482	 11.2 KG	WEEE Logo
			Class 2 Symbol
	CE Mark	Weight (Ready to use)	

<p><b>WEEE Legislation (Waste, Electrical and Electronic Equipment)</b></p> <p>Vacuum cleaner, accessories and packaging should be sorted for environmental-friendly recycling.</p> <p>Only for EU countries: Do not dispose of Vacuum cleaner into household waste!</p> <p>According to the European Directive 2002/96/EC on waste electrical and electronic equipment and its incorporation into national law. Vacuum cleaners that are no longer suitable for use must be separately collected and sent for recovery in an environmental-friendly manner.</p>	<p><b>Safety Critical Components</b></p> <p><b>Mains lead</b> HO5VV-F x 10m x 2 x 1.00mm<sup>2</sup></p> <p><b>Filter Bag</b> (370 - 380 drum) NVM-2 BH &gt;pp&lt; construction 99.6%@0.3µm (470 Drum) NVM-3 AH &gt;pp&lt; construction 99.6%@0.3µm</p> <p><b>Filter</b></p> <p>Tritex NVM 604165 &gt;pp&lt; construction 96.0%@0.3µm</p> <p>Microtex NVM 604311 &gt;pp&lt; construction 99.6%@0.3µm</p> <p>Microfresh NVM 604170 &gt;pp&lt; construction 98.4%@0.3µm</p>
--	---

### PPE

Personal protective equipment that may be required for certain operations.



Ear Protection



Safety Footwear



Head Protection



Safety Gloves



Dust / Allergens Protection



Eye Protection



Protective Clothing



Caution Floorsign

### NOTE:

A risk assessment should be conducted to determine which PPE should be worn.

Motor	AirFlo	Suction	Cleaning Range		Class
1200W	38 L/sec	2400mm	28.8m		II
Capacity Dry	Capacity Wet	Solution Tank	Size	Sound Pressure	Weight
370: 15Litres	370: 9 Litres	370: 6 Litres	370: 355x355x510	78.6 dB (Dry) 78.7 dB (Wet) (IEC 60704-2-1) Uncertainty: 0.2 dB (A)	370: 8.8 Kg

## Information for Wet & Dry Use/Spray Extraction Vacuum Cleaners

### WARNING

Read the instruction manual before using the machine.

Operators shall be adequately instructed on the use of these machines.

As with all electrical equipment, care and attention must be exercised at all times during use, in addition to ensuring that routine and preventative maintenance is carried out periodically to ensure safe operation.

Failure to carry out maintenance as necessary, including the replacement of parts to the correct standard could render this equipment unsafe and the manufacturer can accept no responsibility in this respect.

The machine shall be disconnected from the mains by removing the plug from the supply socket during cleaning or maintenance and when replacing parts or converting the machine to another function.

The machine is not to be used by children or persons with reduced physical, sensory or mental capabilities, or lack of experience or knowledge, unless they have been given supervision or instruction.

Children being supervised are NOT to play with the machine.

This appliance is intended to be assembled, cleaned and maintained by an adult.

This machine is not a toy.

### CAUTION!

If foam/liquid comes out of machine exhaust, switch off immediately. Allow the accumulated liquid to drain out through the machine exhaust, check the float assembly to ensure correct operation, empty the container if full of liquid, reassemble the machine. Immediately upon start up there will be a certain amount of liquid issuing from the machine exhaust which will be the residue of liquid still within the power head. This will be quickly discharged after which the machine should function normally.

Liquid ejected from the machine could be hazardous as a result of its temperature, pressure or chemical content.

This machine is not suitable for the collection of biological hazards, hazardous or explosive dust. You should contact your local distributor if you require a machine capable of performing these tasks.

Ensure that the filtration system fitted to the machine is suitable for the material being collected.

This machine is for indoor use only.

This machine shall be stored indoors only

This product complies with the requirements IEC 60335 -2.68.

When moving from one place to another, consider the weight of the machine.

**NOTE:** This machine is also suitable for commercial use, for example in hotels, schools, hospitals, factories, shops and offices for other than normal housekeeping purposes.

### DO

- Use a bag and filter at all times when using 'dry'.
- Keep your machine clean.
- Keep filters clean.
- Regularly clean the water level limiting float safety valve and examine for signs of damage or correct operation.
- Keep hoses and tubes clear.
- Replace any worn or damaged parts immediately.
- Regularly examine the power cord, if damage is found, power cord must be replaced by a qualified person using the correct Numatic original part.
- Empty dust container frequently.
- Keep diffuser filter (where fitted) clean.

### DON'T

- Use steam cleaners or pressure washers to clean the machine or use the machine in the rain.
- Immerse in water for cleaning.
- Allow any inexperienced repairs. Call the experts.
- Use wet if float valve is not functioning or fitted.
- Use to suck up hot ashes, or lighted cigarette ends.
- Suck up liquid before emptying dirt from container.
- Suck up dirt before emptying liquid from container.
- Run the machine over the power cable during operation as a hazard may occur.
- Pull on the cable to unplug the machine from the power supply.
- Walk over-wet carpets, upholstery or fabrics.
- Walk on clean carpets until fully dry.
- Spray onto people or animals.
- Attempt machine maintenance or cleaning unless the power supply plug has been removed from the supply outlet.

**This machine can be used for dry pick up, wet pick up and cleaning carpet and upholstery**

**Spray extraction machines only**

- Use only approved cleaning preparations.
- Use defoamer if necessary.

**Use of detergents**

When using any detergent with this machine, please ensure you have read the safety data on the container and you are familiar with the procedures to clear up spills, inhalation, skin and eye contact.

**Dry Mode maintenance/fault finding**

If the vacuum cleaner stops working switch off and remove the plug from the wall before investigating were the fault lies.

If the vacuum cleaner will not pick up any debris from the surface, switch off and remove the plug from the wall, inspect the floor tool, wands and hose for blockages, if no blockages are found, the dust bag may be full if the dust bag is not full the filter may be blocked.

**Wet mode / Spray extraction maintenance/fault finding**

If the vacuum cleaner stops working switch off and remove the plug from the wall before investigating were the fault lies.

If the vacuum cleaner has a blockage and will not pick up liquid, switch off and remove the plug from the wall, has the float valve operated, this will shut off the suction and the pitch of the vacuum motor will change. Remove the power head and empty the liquid out of the container, if the container is empty, check that the floor tool wands and hose are not blocked.

If the spray nozzle is blocked a pin maybe used to clear the blockage.  
No spray from nozzle and the pump tone changes, the solution tank is empty, refill the solution tank.  
Flush the system with clean water after use.

After use always inspect the machine for damage.

**NuChem 4 provided with GVE machines only.**

**INSTRUCTIONS FOR USE**

**TEST FOR COLOUR FASTNESS**

Find an out of the way place which is not normally in view and test the carpet / fabric for colour fastness by rubbing the cloth dampened with correctly diluted NuChem 4.

Do not use on velvet type materials or any materials not suitable for wet cleaning according to fabric manufacturers cleaning instructions.

**For Normal soiling:**

Pour one 40ml Measure into 5 litres of cold water.

**For Heavy Soiling:**

Pour two 40ml Measure into 5 litres of cold water.

*NuChem 4 is non-foaming, bactericidal, contains optical brighteners and leaves no tacky residues in the fabric and is enhanced with both a delicate and discreet verbena scent.*

**HEALTH AND SAFETY**

**Caution:**

Keep out of the reach of children and pets.  
Wear suitable gloves.  
Avoid contact with skin and eyes.  
In case of eye contact flush with clean water seek medical attention.

In case of contact with the skin rinse with plenty of clean water.



**CONTENTS:**

Composition:  
Greater than 30% = among other ingredients water

Less than 5% = SODIUM XYLENE SULPHONATE  
CAC: 1300-72-7  
Classified as Irritant  
[X1] r36/37/38

Risk Phrases: R36 / 38: irritating to eyes and skin  
Safety Phrases: S2: Keep out of the reach of children  
S24: Avoid contact with skin and eyes  
S37: Wear suitable gloves

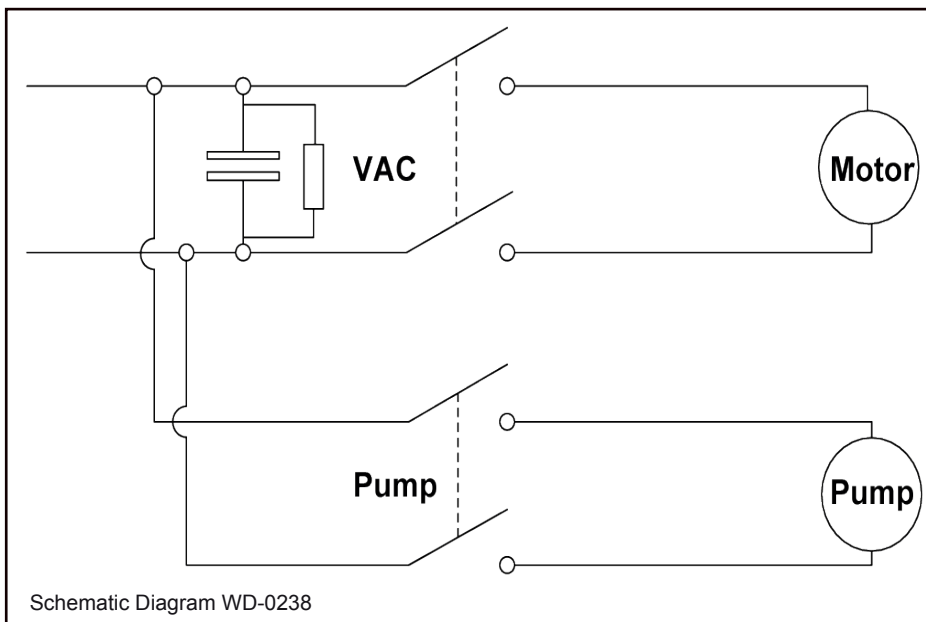

13

**EU DECLARATION  
OF  
CONFORMITY**

We hereby declare under our sole responsibility that the following equipment fulfils all the relevant provisions of the following EU Directives:

---

Machinery Directive 2006/42/EC  
EMC Directive 2004/108/EC  
RoHS Directive 2011/65/EU

---

**Machine Description:** Vacuum Cleaner  
**Type:** GVE, CT, CTT series

---

**Manufactured by:** Numatic International Limited

Relevant standards upon which conformity is declared include:

IEC60335-1:2001 +A1:2004 +A2:2006  
IEC60335-2-2:2002 +A1:2004 +A2:2006  
IEC60335-2-68:2002 +A1:2005 +A2:2007  
IEC60335-2-69:2002 +A1:2004 +A2:2006

EN 55014-1 2001 +A1 2001, +A2 2002  
EN 55014-2 1997 + A1 2001 (Cat II)  
EN 50366 2003 + A1 2006

---

A technical construction file for this equipment is retained at the manufacturer's address under the authorisation of the following signatory:

**Name:** Allyn Boyes      **Position:** Technical Manager

Signed:      Date: 01 /01/2013

Numatic International Limited,  
Chard, Somerset.  
TA20 2GB  
www.numatic.co.uk

GB

Machine Spare Parts	
Heads	
588237	George Head
588242	CT 370 Head
588247	CT 470 Head
Solution Tank	
227065	370 Solution Tank
329164	470 Solution Tank
Drums	
500696	George Drum
500816	CT 370 Blue Drum
500081	CT 380 Blue Drum
500362	470 Blue Drum
Float Cage	
502036	CT / GVE Float Cage
Filter	
604165	TriTex Filter
Dust Bags	
604016	370 / 380 (NVM 2BH) Pack of 10
500081	470 (NVM 3AH) Pack of 10
NuChem Cleaning solution	
219847	500mls NuChem

# Numatic International Warranty

Numatic International Limited warrant to the original purchaser that its products are free of defects in both material or workmanship for the period shown below:-

Homecare and Cleancare Vacuum cleaners.....	2 Years
Rotary Floor Machines.....	2 Years
Twintec Auto Scrubber Dryer.....	1 Year
Vario Ride-On Scrubber Dryer.....	1 Year / 1500 hours
Mopping, Compacts, Combi and Servocare Products.....	1 Year
Individual Accessories and Spare Parts.....	6 Months

Note: This warranty expressly excludes consumable parts such as carbon brushes, floor brushes, mops, batteries etc, that are considered replaceable from time to time during the normal working life of the machine.

- A. The warranty period commences from the date the goods are purchased.
- B. All warranty claims must be processed through the Dealer from whom the equipment was purchased. The Dealer will co-operate with the purchaser throughout the warranty claims procedure and will arrange any necessary repairs using genuine Numatic parts.
- C. If the original Dealer is no longer able to fulfil his obligations please contact Numatic International Limited with full details of the claim and proof of purchase so that this may be processed without delay.
- D. Any warranty claim can only relate to the specific part that is proven to be at fault and for which a replacement will be supplied but cannot be extended to constitute a claim against the complete machine.
- E. Numatic International will supply the Dealer with any warranty parts required, subject to the claim being validated, after return of the faulty items in accordance with Numatic International Limited's General Conditions of Sale.
- F. Claims will not be accepted if they are the result of fair wear and tear, misuse or abuse of any kind.
- G. No replacement will be given unless the appropriate evidence of the validity of the claim has been provided to the satisfaction of Numatic International Limited.
- H. Numatic International Limited reserve the right to charge for any unnecessary work carried out as a result of an invalid claim.
- I. No variation to this warranty may be made or implied by any member of Numatic International Limited or its Dealers unless such variation is in writing and authorised by the Company



Numatic International Limited, Chard, Somerset, TA20 2GB  
Telephone: 01460 68600 Fax: 01460 68458  
© Numatic International Limited

Numatic International Limited, Chard, Somerset, TA20 2GB, ENGLAND.

Telephone 01460 68600 Fax: 01460 68458

[www.numatic.co.uk](http://www.numatic.co.uk)

16

Subject to change without prior notice.

© Numatic International Limited 233871 / 04/13(A10)